



raise'UP
f o o t w e a r





-KIDS SIZING AND FEETING IN SHOES IS ALWAYS A PROBLEM...

- SPECIALLY IN THE SMALL SIZES 16-25 ...
- KIDS DO NOT SPEAK YET... USUALLY NO CLAIM
- BAD DEFORMATIONS CAN BE CAUSED BY HARMFUL SHOES

- WHEN IS TIME TO CHANGE ?

- GROWING UP TIME IS NOT SAME TO ALL.
- PARENTS CAN SEE AND MEASURE THE PROCESS!!!
- CAN BE ADJUSTABLE WITH THE INNER SOCKS THICKNESS DIFFERENCE...

- LONG LIFE SHOES

- A PAIR OF SHOES CAN BE USED FOR A LONG TIME
- SPECIALLY FOR POOR PEOPLE, WE CAN OFFER A PAIR OF SHOES THAT LAST LONGER.....
(CHARITY INSTITUTIONS, SCHOOLS, GOVERNMENTS, COMPANIES, SOCIAL INSTITUTIONS, ETC...)



2 - The target market of this new type of footwear will potentially be all children, in which their parents find it difficult to keep up with the normal growth of their child's foot, and prevent problems and deformations in the normal development of the foot. This type of footwear will be an ideal model, to use in a casual way, in the various stages of growth.

//raise'Up//
f o o t w e a r





MAKE A PAIR OF SHOES, THAT CAN BE ADJUSTABLE, IN SIZE, IN TIME!





EXAMPLE BASE OUTSOLE...



f o o t w e a r

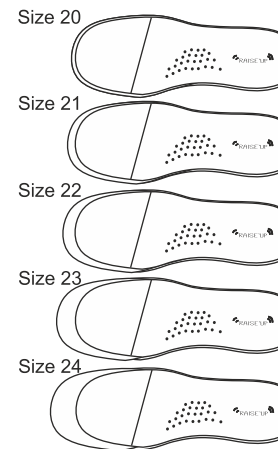

DEFORMATION SIZING
6,6MM SIZE GRADING
SIZE BY SIZE

MAX ACCEPTABLE 5 SIZES

SOCK INNER TO BE MORE
COMFORTABLE OR FOR AN
QUALITATIVE RANGE

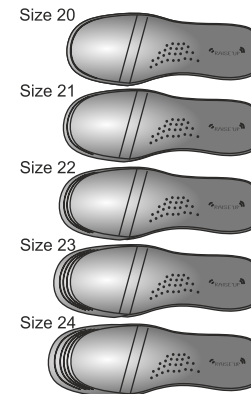

SIZES = ADJUSTMENT 5 SIZES = 1 PAIR





Size 23



Size 22



Size 21



Size 20



Size 19

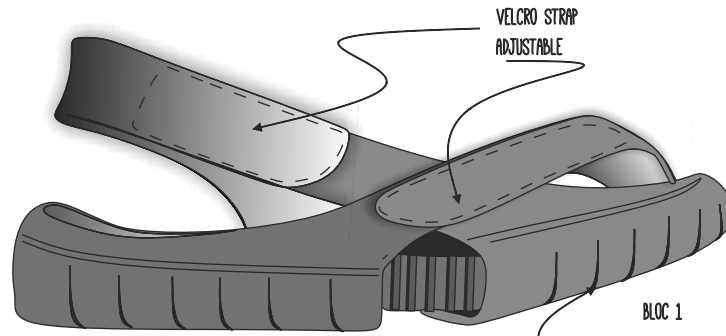

STITCHING ENGRAVING

Stitching Canal

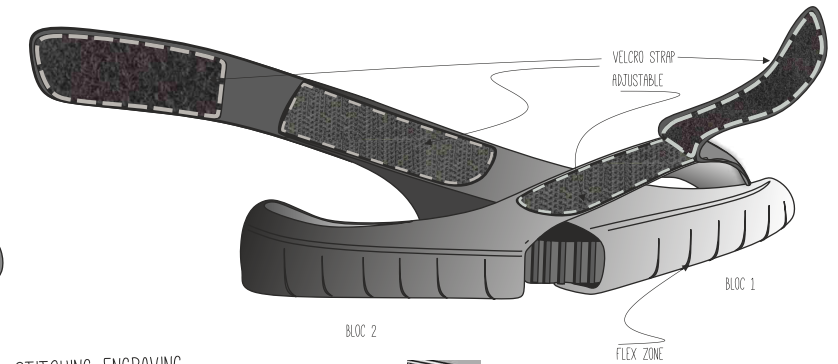
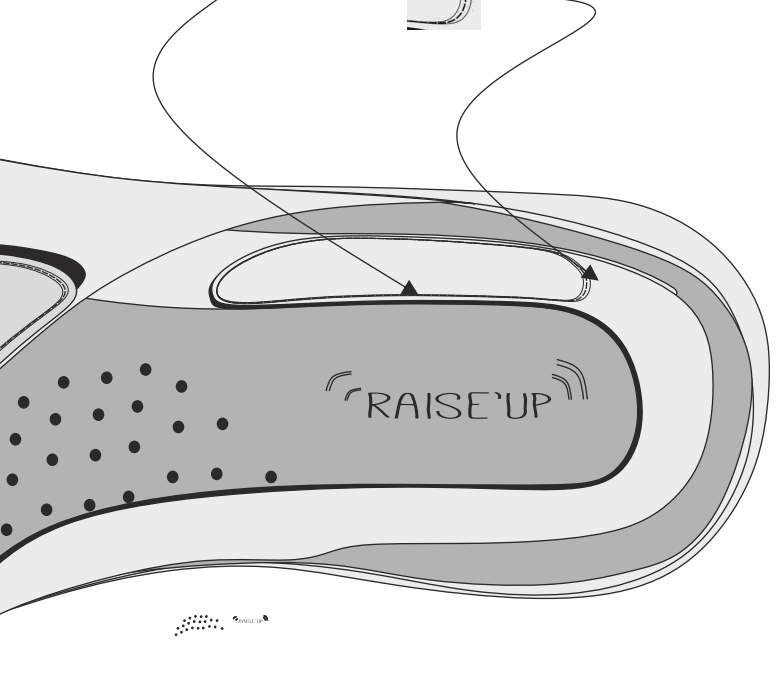

UPPER PART, DESIGN SOLUTION / CONCEPT / POSSIBLE COMBINATIONS...



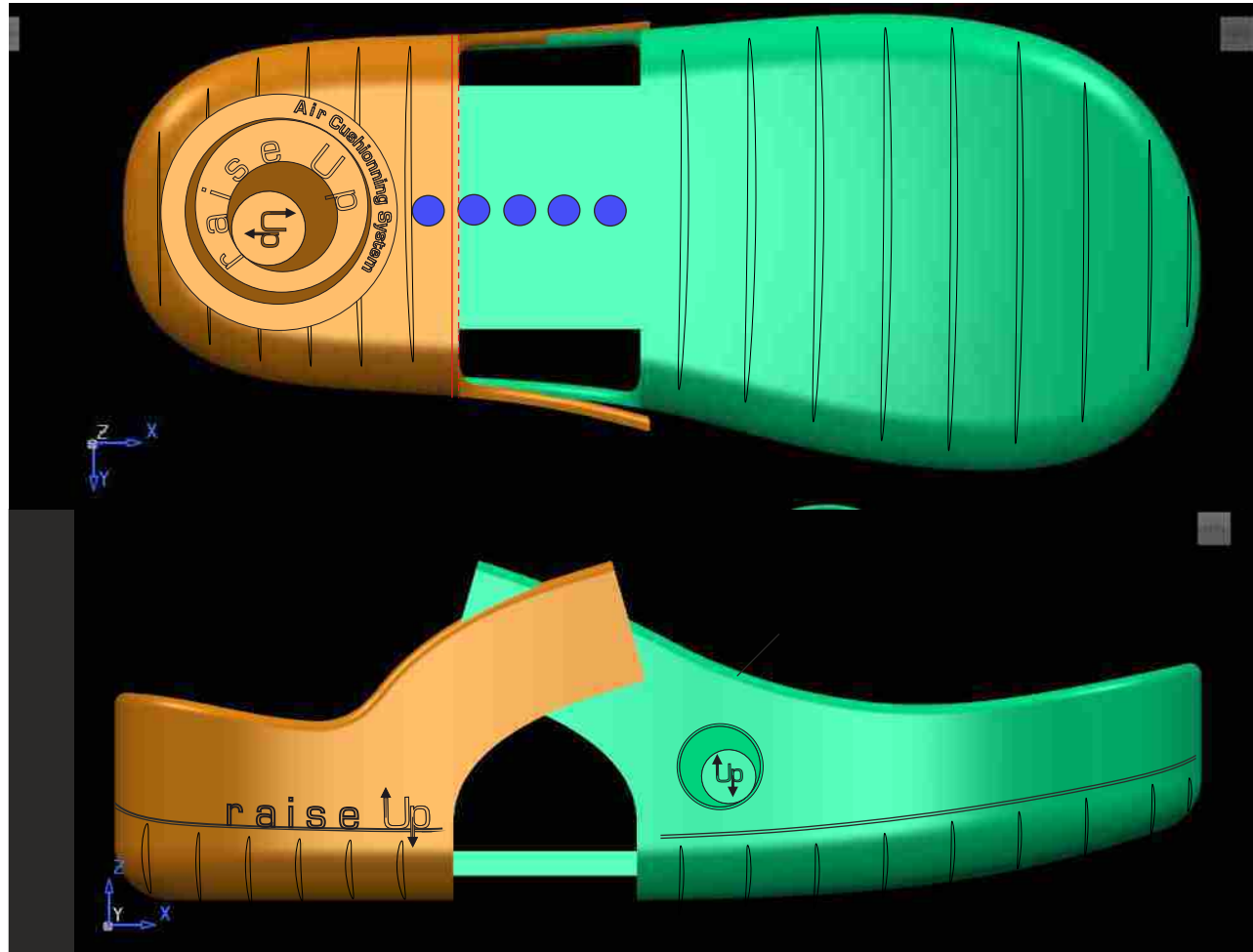

UPPER PART, DESIGN SOLUTION / CONCEPT / POSSIBLE COMBINATIONS...



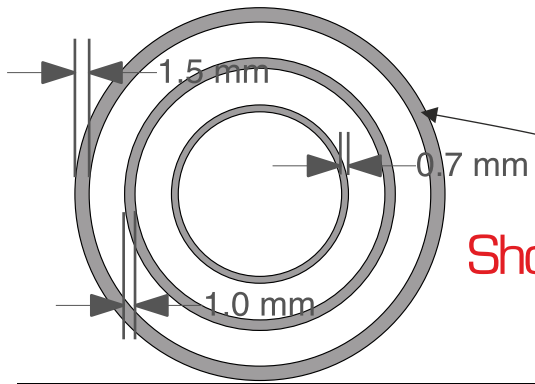

Shock Absortion

PIN to remove to
size change - 5 sizes

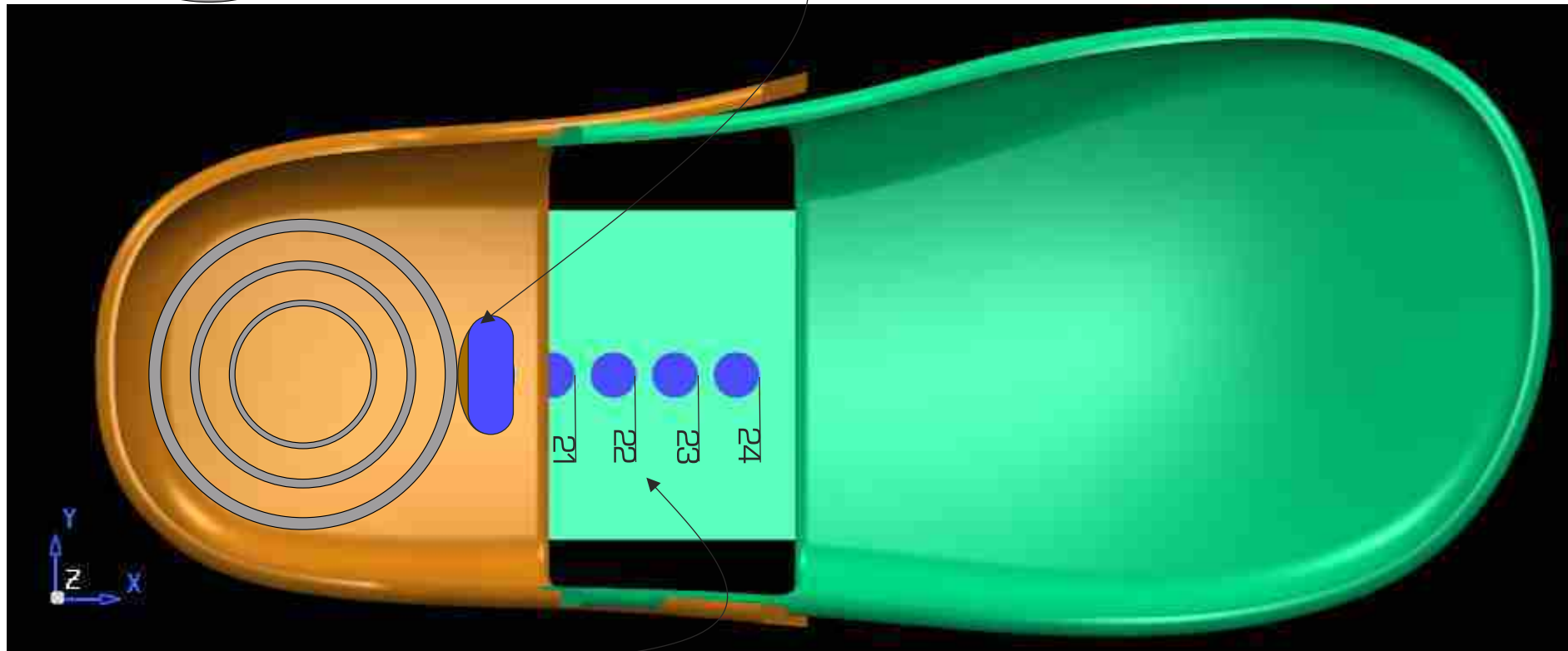

Inside Marking Molds
Size in FR EU marking





VARIATION 1 OPEN SANDAL

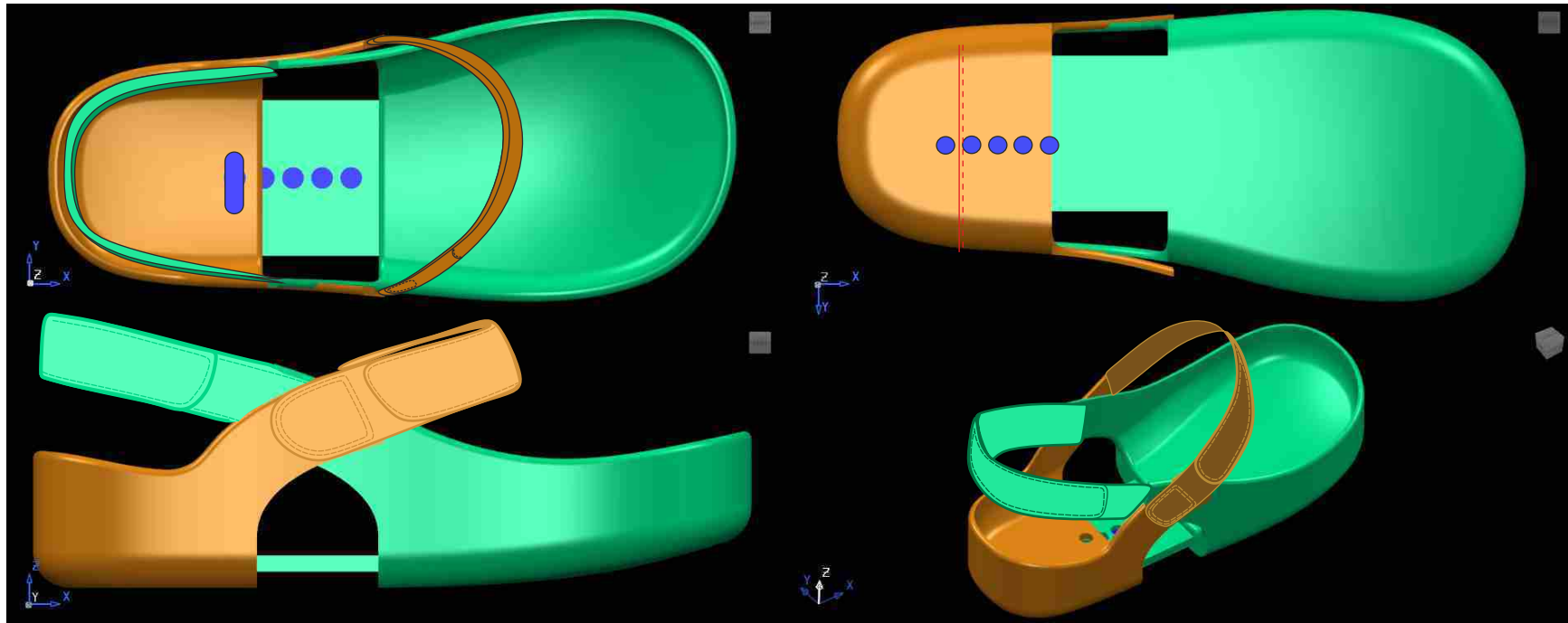



VARIATION 2 SEMI OPEN TOE

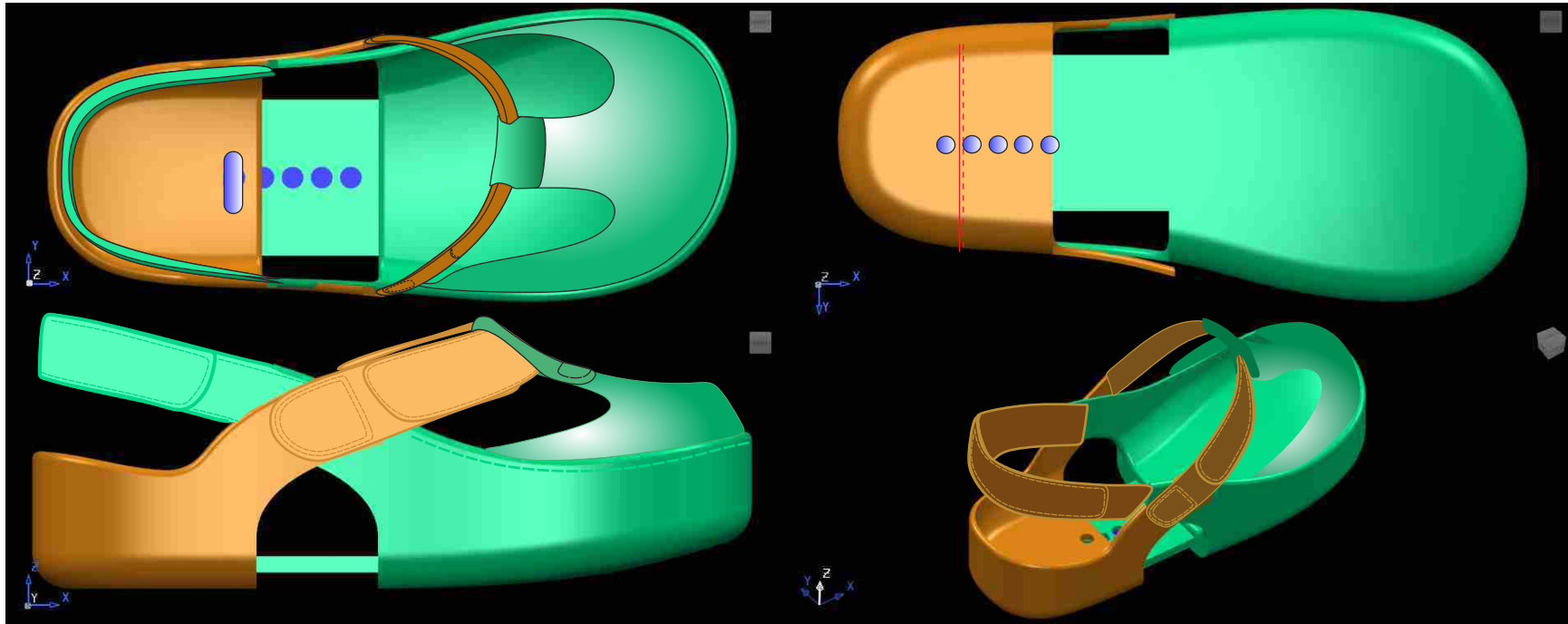



VARIATION 3 CLOSE TOES

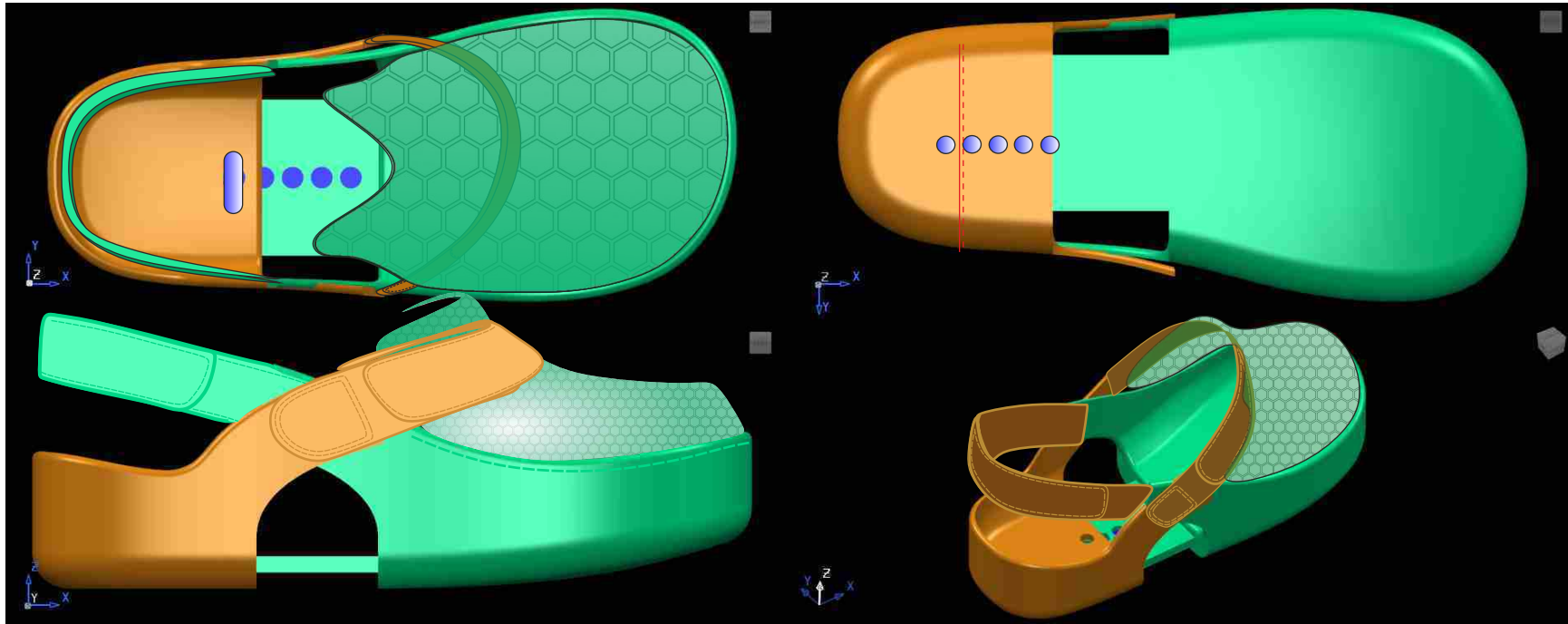



BUSINESS MODEL : COMPETITION

All brands

Size by size shoes

Adjustable shoes 1 or 2 size up

- Medical footwear
- Protheses
- Snow Footwear - Sports
- Lycra sport shoes
- INCHworm shoe

“raise’Up”
f o o t w e a r

Upper and Sole Adjustable 5 sizes

Upper Adjustable 5 sizes

♥ THE SHOE THAT GROWS



SIZES = ADJUSTMENT 5 SIZES = 1 PAIR





BUSINESS MODEL : MARKET SIZE

-MARKET:

There are 250 babies born every minute in World - more than 131,4 millions in 2018 year. (CIA)

- We expect to sell 0,001% pairs for the new born babies = 130 000 Pairs/Year

- There are 5 075 millions in 2017 year in 28-EU. (Eurostat - Fertility Statistics)

- We expect to sell 0,001% pairs for the new born babies

- There are 26 millions in 2018 year in India, 51 per minute. (MedIndiaClock)

- We expect to sell 0,001% pairs for the new born babies



- Population will pass from 1,3 billions to 2,5 billions in the year 2050 in Africa. (DW news)

- We expect to offer 1 pair over 3 pairs sold out.

SIZES = ADJUSTMENT 5 SIZES = 1 PAIR





BUSINESS MODEL : STRATEGY

Product-

- Production Cost / Target Price : 5Euros/ Pair.
 - Moulds Development / 5 Molds Sets (sizes : 19-40) 4 Molds/ per size = 5000Euros/Size x 5 Molds Units = 25 000Euros
 - Pilot Order, to test all the molds and make stock - 5 000pairs. / = 25 000Euros
 - PVP price - 19,90 Euros.
- **RaiseUp - 50 000Euros to lunch product from 20% sale company. (will pay molds and 1st 5 000 pairs order + 5 Molds- sizess 19/40)**

SALES:

- International Fair - 2 per Year/ 2years +/- 10.000Euros per Fair - (Pitit Uomo, Project Sole NY,...)
- Contact big retailers for B2B distribution (Decathlon, ElCorteIngles, Seaside, etc...)
- Co-branding with Large Kids Brands
- Colaboration with Humanitary ONG's / Governaments / Shools / Medical Instituitons
- On-Line sales - On each 3 sold pairs, We'll offer 1 pairs for an charity institutions.

SIZES = ADJUSTMENT 5 SIZES = 1 PAIR/ 19,90EUROS



TEAM:



Manager / Product - Designer
Jose Brochado



IT- Management - Back Office
Antonio Nunes



Sales - Finances - Fiscal
Tiago Pinto

